



victron energie

**USER MANUAL
GEBRUIKSAANWIJZING
GEBRAUCHSANWEISUNG
MODE D'EMPLOI**

Phoenix 12/800
Phoenix 12/1600
Phoenix 24/1800



SECTIONS page

English	3
Nederlands	31
Deutsch	59
Français	87



This publication or parts thereof, may not be reproduced in any form, by any method, for any purpose.

VICTRON ENERGIE B.V. MAKES NO WARRANTY, EITHER EXPRESSED OR IMPLIED, INCLUDING BUT NOT LIMITED TO ANY IMPLIED WARRANTIES OF MERCHANTABILITY OR FITNESS FOR A PARTICULAR PURPOSE, REGARDING THESE VICTRON ENERGIE PRODUCTS AND MAKES SUCH VICTRON ENERGIE PRODUCTS AVAILABLE SOLELY ON AN "AS - IS" BASIS.

IN NO EVENT SHALL VICTRON ENERGIE B.V. BE LIABLE TO ANYONE FOR SPECIAL, COLLATERAL, INCIDENTAL, OR CONSEQUENTIAL DAMAGES IN CONNECTION WITH OR ARISING OUT OF PURCHASE OR USE OF THESE VICTRON ENERGIE PRODUCTS. THE SOLE AND EXCLUSIVE LIABILITY TO VICTRON ENERGIE B.V., REGARDLESS OF THE FORM OF ACTION, SHALL NOT EXCEED THE PURCHASE PRICE OF THE VICTRON ENERGIE PRODUCTS DESCRIBED HEREIN.

For conditions of use and permission to use this manual for publication in other than the English language, contact Victron Energie B.V.

Victron Energie B.V. reserves the right to revise and improve its products as it sees fit. This publication describes the state of this product at the time of its publication and may not reflect the product at all times in the future.



victron energie

USER MANUAL

Phoenix 12/800
Phoenix 12/1600
Phoenix 24/1800



victron energie

Manual **CE**

3

INTRODUCTION

Victron Energie has acquired international fame in the field of developing and producing electrical power supply systems. Thanks to the constant efforts of the development department in particular, Victron Energie obtain this world fame. This department is involved in research into and execution of facilities for implementing new technologies that can make significant technical and economic contributions to Victron Energie products.

This proven philosophy has resulted in the development of a complete series of power supply equipment incorporating the latest technical developments. Victron Energie equipment meets the most stringent standards and regulations. The range of high quality, dependable Inverters and Battery Chargers produced by Victron Energie can be used to generate 230V AC power in places where no permanent connection to mains electricity is available.

An automatic stand-alone power system can be created with a configuration comprising a Victron Energie inverter, battery charger, mains manager (if required) and, last but not least, batteries with sufficient capacity.

Victron Energie equipment is suitable for all types of electrical equipment for domestic, industrial and specialist use, including instruments susceptible to interference. Victron Energie systems are high quality energy sources that guarantee fault-free operation.

This manual describes the installation, operation and the practical use of the Phoenix Inverter. This manual also provides information about protection devices and the technical specifications of the Phoenix Inverter.

CONTENTS

1.	DESCRIPTION.....	8
1.1	General.....	8
1.2	Phoenix Inverter.....	8
1.3	Serial interface.....	9
2.	PROTECTION DEVICES.....	10
2.1	Start up power.....	10
2.2	Temperature protection.....	10
2.3	Low battery voltage protection.....	10
2.4	High battery voltage protection.....	10
2.5	Reverse polarity indicator.....	11
2.6	Ripple voltage protection.....	11
2.7	Current protection.....	11
3.	INSTALLATION AND CONNECTION.....	12
3.1	Location.....	12
3.2	Requirements for installation.....	12
3.2.1	Requisites.....	12
3.2.2	Battery cables.....	13
3.3	Connection of wiring.....	13
3.4	Connection of battery cables.....	14
3.5	Connection of 230 V AC cables.....	15
3.6	Connection of remote switch.....	15
3.7	Connection of serial interface.....	16
4.	OPERATION.....	17
4.1	Overload indicator.....	18
4.2	Low battery voltage indicator.....	18
4.3	High temperature indicator.....	18
4.4	Adjustment.....	19
4.5	60 Hz setting.....	19
4.6	Efficiency management.....	19
4.7	Calculation of battery capacity.....	20
4.8	Maintenance.....	21
5.	TROUBLE-SHOOTING TABLE.....	22
5.1	Problem solving.....	22

- 6. TECHNICAL SPECIFICATIONS..... 24
 - 6.1 Inverter input..... 24
 - 6.2 Inverter output 25
 - 6.3 General..... 27
 - 6.4 Mechanical 27

- 7. DRAWINGS 28
 - 7.1 Dimensions..... 29
 - 7.2 Connection diagram 30



1. DESCRIPTION

1.1 General

All Phoenix Inverter's are extensively tested before leaving the factory. This guarantees correct operation. For the purposes of transport the equipment packed in shock-absorbing polystyrene foam and a rigid cardboard carton.

The Phoenix Inverter has a rigid aluminium housing, suitable for floor and wall mounting. The AC and DC terminals along with the connections for remote control (optional) are accessible via the front of the housing. The front panel can be removed using a screwdriver.

1.2 Phoenix Inverter

The model name of the Phoenix Inverter is composed of the following elements:

Example: Phoenix Inverter 12/1600

"12" = 12 Volt battery voltage.

"1600" = 1600 Watt continuous output power.

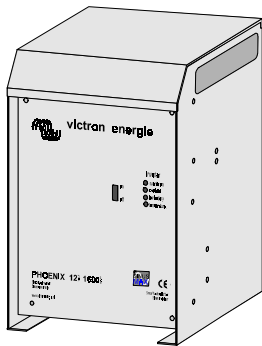

The inverter supplies a pure sinusoidal voltage of 230 V AC, 50/60 Hz (crystal-controlled).

The Inverter has been specially developed for mains powered equipment that depends on pure sinusoidal input voltage for effective and efficient operation.

The Phoenix Inverter uses high frequency switching technology in combination with a low frequency transformer, which results in a high output and a high start-up power. The 'no-load' power consumption is described in section 6.

Ampere = <i>unit of current</i>	Volt = <i>unit of voltage</i>
Watt = <i>unit of power</i>	Hertz = <i>unit of frequency</i>
Volt rms = <i>Root mean square value of the voltage</i>	

The output power of the Phoenix inverter is:

Model	Continuous load	Start up power	P30 power
Phoenix 12/800	800 W	2250 W	1250 W
Phoenix 12/1600	1600 W	4500 W	2500 W
Phoenix 24/1800	1800 W	6000 W	3000 W

1.3 Serial interface

The Phoenix Inverter can be connected to a serial databus. In combination with an RS485 interface and the Victron Information Protocol, V.I.P., communication can be carried out with one or more remote panels. It is also possible to connect several items of Victron Energie equipment to this databus. The total of the number of units and panels that can be connected to this databus is a maximum of 32 items. Each unit is given a unique identification code during production so that the remote panel can read out or adjust each unit separately.

By means of this databus and a remote panel it is then possible to change the settings of the Phoenix Inverter remotely. It is also possible to obtain information remotely on the output voltage, current and frequency of the inverter.

2. PROTECTION DEVICES

A number of protection devices are incorporated in the Phoenix Inverter that protect the unit and the equipment connected from internal electronic damage.

2.1 Start up power

The Phoenix Inverter can deliver a high power for short periods (see Table in paragraph 1.2). This power is electronically limited. If the inverter is overloaded the 'overload' LED will flash. If the overload is too high the equipment will switch off and the 'overload' LED will stay on continuously. After approx. 30 seconds the inverter starts up again automatically.

2.2 Temperature protection

The temperature of the electronics is continuously measured. Thanks to this temperature monitoring the equipment is switched off if the temperature threatens to rise too high due to shorting, overload or an extremely high ambient temperature. The 'temp.' LED will flash to indicate that the critical temperature has almost been reached. If the internal temperature is too high, the 'temp.' LED will remain on continuously and the equipment switches off. As soon as the temperature has fallen sufficiently, the equipment starts up again automatically.

2.3 Low battery voltage protection

During operation, as soon as the battery voltage reaches a value that is too low the inverter is switched off. When the input voltage has risen again the inverter comes back into operation after approx. 30 seconds.

2.4 High battery voltage protection

During operation as soon as the battery voltage has reached a value that is too high the inverter is switched off. When the input voltage has fallen again the inverter comes back into operation after approx. 30 seconds.

2.5 Reverse polarity indicator

The Phoenix Inverter has a reverse polarity indicator. By only fitting the fuse in a later stage in the unit one can see whether the battery voltage offered is of the right polarity. If the polarity is correct the fuse can be fitted and the unit is ready for operation.

2.6 Ripple voltage protection

The Phoenix Inverter is protected against a ripple voltage. Too high a ripple voltage can be caused by a low capacity battery or by the battery cables being too long and / or too thin. Either dynamos can be the perpetrator of a too high ripple voltage.

If the value of the ripple voltage on the input is high the inverter will give an alarm; the 'low batt.' LED and the 'overload' LED will flash, see section 6 for the maximum value of the ripple voltage. If the input voltage ripple is too high or the preceding alarm situation remains for a period of 21 minutes, the inverter will switch off and the following alarm indication can be seen; the 'low batt.' LED and the 'overload' LED will remain on continuously.

The Phoenix Inverter must be reset by switching it off and on again.

2.7 Current protection

The output of the inverter is also protected against shorting. The maximum output current is electronically limited to a maximum current of 20 A (for 12V) and 27 A (for 24V).

3. INSTALLATION AND CONNECTION

3.1 Location

The Phoenix Inverter must be installed in a dry, well-ventilated room.

TAKE CARE!

Too high an ambient temperature has the following consequences:
lower output, shorter life or complete shut-down of the Phoenix Inverter.
See for more information section 6 (“Technical specifications”).

The housing of the Phoenix Inverter is suitable for floor and wall mounting. For mounting purposes there are holes on the bottom and back of the housing. For the relevant dimensions please refer to section 7 (“Drawings”).

The Phoenix Inverter has a built-in fan. There are no restrictions with regard to the position in which the Inverter is mounted. Nonetheless it is recommended that the unit be mounted vertically. The cooling is in fact best in this position. Take care that the inside of the Inverter is also easily accessible after installation.

The distance between the Phoenix Inverter and the battery must be kept as short as possible to minimise the voltage loss in the cables.

3.2 Requirements for installation

Use the tools mentioned in paragraph 3.2.1 for the installation of the Phoenix Inverter.

3.2.1 Requisites

- Two battery cables (maximum length 6 metres) including battery terminals, see for the diameter the Table in 3.2.2.
- A box spanner (13 mm or M8) for tightening the connecting bolts.
- A box spanner (8 mm or M5) for the connection of the copper strip.
- A screwdriver (no. 2) for the connection of the 230 V AC cables.

3.2.2 Battery cables

The Table below shows recommended battery cables. The cross-section of the battery cables is such that these are suitable for continuous load and peak load.

Model	Length 0 – 1.5 metres	Length 1.5 – 6 metres
Phoenix 12/800	25 mm ²	35 mm ²
Phoenix 12/1600	50 mm ²	70 mm ²
Phoenix 24/1800	35 mm ²	50 mm ²

Tighten the nuts firmly to prevent contact resistances.

3.3 Connection of wiring

The connection of the wiring is an important step in the installation.

The connection points are located on the printed circuit board in the inverter (see figure 1). The cable terminals are given a code ("+" or "-").

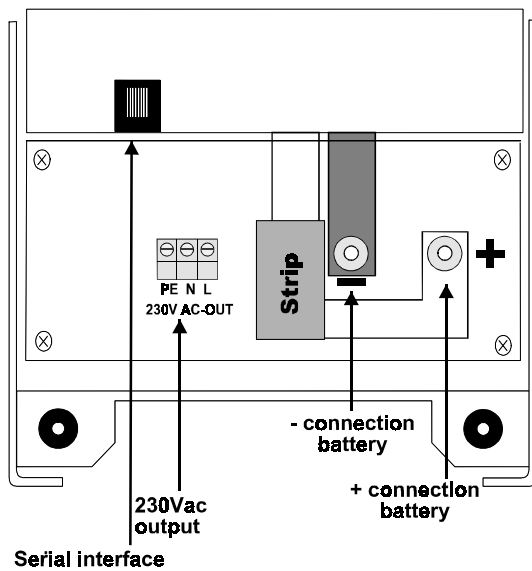
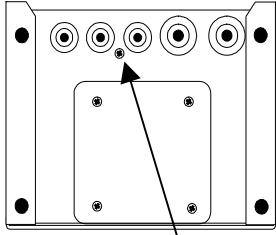

Figure 1



Ground connection



Ground screw

Figure 2

For the ground connection the ground wire (ground conductor) of the mains current must be connected to the ground of the AC output terminal block “PE” (figure 1). The circuit thus created is however only active if the housing is also connected to the ground. The housing is fitted with an M4 ground screw for this purpose (figure 2).

To close the circuit, this housing ground must be connected to the ground. On ships the housing can be "grounded" by connecting it to the ship's hull or the ground plate. In vehicles grounding can be made with the chassis.

3.4 Connection of battery cables

In order to fully utilise the capacity of the Phoenix Inverter (in particular for peak loads), only battery cables of the right thickness must be used. See paragraph 3.2.2.

Procedure

Proceed as follows for connecting the battery cables:

- Unscrew the four screws on the front of the housing.
- Connect the battery cables to: the '+' (red) on the right and the '-' (black) on the left.
- If the battery cables of the Inverter are changed over (+ on – and – on +), the red LED will come on.
- If the red LED comes on, disconnect the cables and connect them correctly.
- Fit the copper strip.
- Check whether all the connections are properly tightened.
- If you disconnect the battery again you must first disconnect the other equipment connected to the battery.

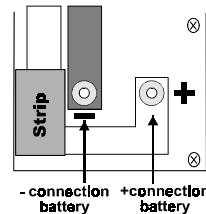
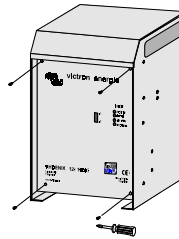

3.5 Connection of 230 V AC cables

The terminal block is located on the printed circuit board (see figure 1). The 230 Vac equipment must be connected to the inverter using a three-core cable. Use a three-core cable with a flexible core and a cross-section of 2.5 to 4 mm². The connection points are clearly coded. From left to right: "PE" (ground), "N" (neutral conductor) and "L" (phase).

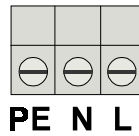

3.6 Connection of remote switch

The Phoenix Inverter can be switched on and off using the remote control. If with the remote control contact is made between "ground" and "on" then the Phoenix Inverter switches on (see figure 3).

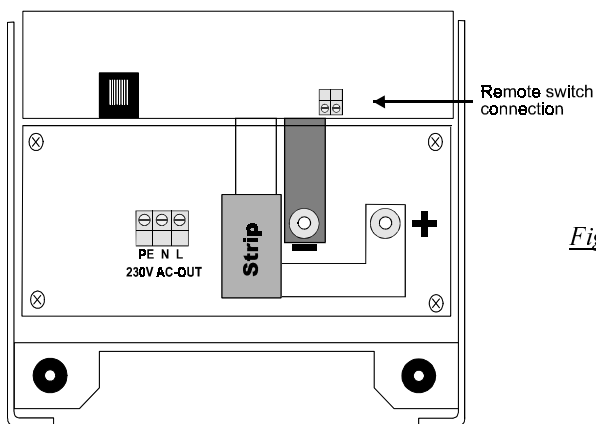

Figure 3

3.7 Connection of serial interface

The serial databus can be connected using a standard 8-pole data cable. For this a standard 8-pole dataconnector can be used which can be connected to the connector of the Phoenix Inverter, see figure 1. This cable may have a maximum length of 100 m.

If several units are connected to the databus connected this can be done using a simple splitter box. Equipment connected to the databus and not switched on has no effect on the operation of the databus.

Pinning of the 8-pole data cable:

Pin no.	Description
1 NC	Not connected
2 +VDC_out	Positive supply voltage for a remote panel
3 Ground	Ground
4 Data_ser_A	Serial dataline A
5 Data_ser_B	Serial dataline B
6 R_Standby	Remote standby
7 NC	Not connected
8 NC	Not connected

- After installation replace the front of the housing and tighten the four screws.

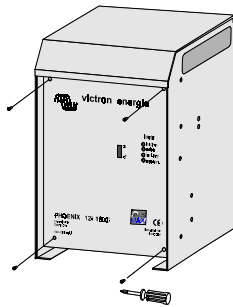

4. OPERATION

The switch and the LEDs are located on the front of the Phoenix Inverter (see figure 4).

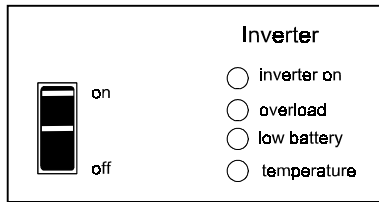

Figure 4

LEDs:

- inverter on : lights up when no mains voltage is present and the switch is set to “on”.
- overload : lights up if too high a load is connected to the inverter.
- low battery : lights up if the battery voltage is too low.
- temperature : lights up if the inverter or charger is switched off because of too high an ambient temperature.

on/off switch

Using the “on/off” switch the Phoenix Inverter can be switched to on or off, (see figure 4).

If the switch is set to “on” then the inverter will be switched.

4.1 Overload indicator

If the inverter becomes overloaded, the "overload" LED will flash. If the overload is too high the inverter will automatically switch off, then the 'overload' LED will remain on continuously. After approx. 30 seconds the inverter starts up again automatically.

4.2 Low battery voltage indicator

The "low battery" LED will flash if the battery voltage is lower than 10,9 Vdc (at 12 V) and 21,8 Vdc (at 24 V) and the LED lights up continuously when the input voltage of the inverter is too low. The inverter is immediately switched off automatically in such a case.

Too low an input voltage is caused by:

- An exhausted battery.
- A relatively low battery capacity compared with the high battery load as a result of which the terminal voltage falls considerably.
- Battery cables too thin and/or too long.
- Poor condition of the batteries.
- Bad connections at battery or inverter.

As soon as the input voltage has risen sufficiently the Phoenix Inverter starts up again after approx. 30 seconds.

4.3 High temperature indicator

The Phoenix Inverter has forced cooling using a fan. This fan runs at half speed from a load of approximately 0.4x the nominal load. The speed then increases linearly, as the load becomes greater.

In case of a high ambient temperature the "temp" LED comes on and the fan runs at full speed. When such a situation occurs, the Phoenix Inverter is automatically switched off. The Phoenix Inverter starts up again as soon as the temperature has fallen sufficiently.

4.4 Adjustment

To be able to adjust the output voltage of the inverter, the housing of the Phoenix Inverter must be opened. For this unfasten the four screws on the front.

The output voltage of the inverter is adjusted as standard to 230 V AC. Using potentiometers R52 (see figure 5) the output voltage can be changed by approx. +5% and -20%.

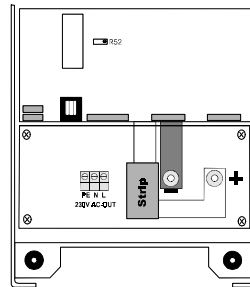
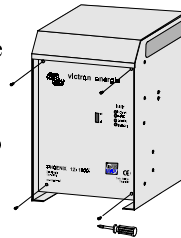

Figure 5

4.5 60 Hz setting

Some equipment only works correctly at 50 Hz or at 60 Hz. The Phoenix Inverter can generate a 230 V AC sinusoidal alternating voltage with a frequency of 50 Hz or 60 Hz. The frequency can be set at 60 Hz by moving DIP switch DS5 to the left, see the figure alongside. As standard the inverter is set at 50 Hz.

DS 8
DS 7
DS 6
DS 5
DS 4
DS 3
DS 2
DS 1



4.6 Efficiency management

In the design special attention has been paid to an extremely low own consumption with low or absent load. As a result an economy-position is superfluous and all small consumers such as clocks, electronic displays and connected equipment continue to operate normally in a stand-by position.

4.7 Calculation of battery capacity

The required minimum battery capacity can be calculated. As a starting point for the calculation the duration and the absorbed power of the equipment which must be supplied using a Phoenix Inverter must be known.

For the calculation first make a list in which the equipment that must be supplied using a Phoenix Inverter is summed up. Note for each separate unit the absorbed power and multiply that by the time (in hours) during which power is absorbed (Watt-hours). Count the internal loss of the Phoenix Inverter here.

The internal loss is calculated from two components. If the inverter is supplying power, the Phoenix Inverter has an output of 85%. A further 15% must therefore be added to the calculated power. If no power is supplied one must take into account the no-load consumption of the Phoenix Inverter (see section 6).

Then determine the number of ampere-hours (Ah) by dividing the absorbed power by the nominal battery voltage (12 Volt or 24 Volt). The result of this calculation gives the current consumption in ampere-hours and hence the total consumption capacity of the battery in ampere-hours (Ah).

Multiply this value by a safety factor of 1.7. The result thus obtained indicates the required battery capacity.

Below is an example of this calculation, applied to the Phoenix 12/1600.

Unit	Power	Duty cycle in hours	Consumption
CTV	200 W	4	800 Wh
Video recorder	50 W	4	200 Wh
Hi-fi installation	100 W	6	600 Wh
Lighting	300 W	3	900 Wh
Computer	100 W	3	300 Wh
Cooking ring	750 W	1	<u>750 Wh</u>

Total consumption **3550 Wh**

Internal loss (3550/85%) x 15% 626 Wh

Internal loss during 12 hours without power supply
(12 hours x 6.5 W) 78 Wh

Total power consumption **4254 Wh**

Total consumption capacity of the battery (4254 Wh/ 12 Volt): 354,5 Ah

Daily consumption	Safety factor	Required Ah
354,5 Ah	x 1.7	= 602,7 Ah

Based on a required Ah value of 602,7, the battery capacity must be 600 Ah.

For sealed and gel batteries a different recommended safety margin may apply, sometimes to 1.3. As a result it is possible to use a battery with a smaller capacity. For this consult the specifications of the manufacturer.

4.8 Maintenance

The Phoenix Inverter requires no specific maintenance. It is sufficient for all the connections to be checked once per year. Prevent the Phoenix Inverter getting damp and keep the unit as clean as possible.



5. TROUBLE-SHOOTING TABLE

Using the step-by-step plan below the commonest faults can quickly be traced. Before tests are carried out with the inverter the other 12 V DC or 24 V DC and 230 V AC equipment must be disconnected from the batteries and the inverter.

5.1 Problem solving

If the fault cannot be solved, consult your Victron Energie dealer.

Problem	Cause	Solution
The inverter does not work when it is switched on.	The battery voltage is too high or too low.	Make sure the battery voltage is within the right value, see paragraph 7.
The “low battery” LED flashes.	The battery voltage is low.	Charge the battery or check the battery connections.
	There is a voltage loss in the battery cables of more than 2 Volts.	Replace the battery cables or connect them properly.
The “low battery” LED is on.	The inverter switches off because the battery voltage is too low.	Charge the battery or check the battery connections.
The “overload” LED flashes.	The load on the inverter is above the nominal load.	Disconnect part of the load.
The “overload” LED is on.	The inverter is switched off because the load is too high.	Disconnect part of the load.
The “temperature” LED flashes.	The ambient temperature is high, or the temperature of the internal components is high or the load is too high.	Place the inverter in a cool and well-ventilated environment or disconnect part of the load.

Problem	Cause	Solution
The “temperature” LED is on.	The inverter is switched off as a result of too high an ambient or component temperature or the load is too high.	Place the inverter in a cool and well-ventilated environment or disconnect part of the load.
The “low battery” and “overload” LED’s flash.	Low battery voltage and too high a load or the ripple voltage on the input reaches 10% of the DC value of the input voltage.	Charge the batteries, disconnect part of the load or fit batteries with a higher capacity. Fit shorter and/or thicker battery cables. Check dynamo.
The “low battery” and “overload” LED’s are on.	The inverter is switched off as a result of too high a ripple voltage on the input.	Fit a ripple-voltage suppresser and/or batteries with a higher capacity. Fit shorter and/or thicker battery cables and reset the inverter (switch off and back on again).
One alarm LED is on and the second flashes.	The inverter is switched off as a result of the alarm of the LED that is on. The flashing LED indicates that the inverter is about to be switched off by the alarm in question.	Check this table to take action depending on the alarm.



6. TECHNICAL SPECIFICATIONS

6.1 Inverter input

Input voltage nominal

Phoenix 12/800	12 Vdc
Phoenix 12/1600	12 Vdc
Phoenix 24/1800/50	24 Vdc

Input voltage range

Phoenix 12/800	9,5 – 16,1 Vdc
Phoenix 12/1600	9,5 – 16,1 Vdc
Phoenix 24/1800	19,0 – 32,2 Vdc

Switch-on voltage (low)

Phoenix 12/800	10,9 Vdc
Phoenix 12/1600	10,9 Vdc
Phoenix 24/1800	21,8 Vdc

Switch-off voltage (low)

Phoenix 12/800	9,5 Vdc
Phoenix 12/1600	9,5 Vdc
Phoenix 24/1800	19,0 Vdc

Switch-off voltage (high)

Phoenix 12/800	16,1 Vdc
Phoenix 12/1600	16,1 Vdc
Phoenix 24/1800	32,2 Vdc

Voltage ripple

max. 1,25 Vrms AC on the nominal DC input voltage for 12 V.
max. 2,5 Vrms AC on the nominal DC input voltage for 24 V.

Input current nominal	
Phoenix 12/800	80 A at 12 V/800 W
Phoenix 12/1600	160 A at 12 V/1600 W
Phoenix 24/1800	90 A at 24 V/1800 W

Input current maximum:	
Phoenix 12/800	200 A
Phoenix 12/1600	400 A
Phoenix 24/1800	300 A

Power consumption no-load 6 W

6.2 Inverter output

Output voltage	230 Vac +/- 1 %
Output voltage range	185 Vac – 245 Vac
Frequency	50 / 60 Hz +/- 0.2 % (crystal-controlled)
Waveform output voltage	pure sinusoidal
Total harmonic distortion	maximum 2 %
Power factor (cos phi)	0.2 capacitive to 0.4 inductive
Nominal power	
Phoenix 12/800	800 W (cos phi = 1.0; 0°C - +40°C)
Phoenix 12/1600	1600 W (cos phi = 1.0; 0°C - +40°C)
Phoenix 24/1800	1800 W (cos phi = 1.0; 0°C - +40°C)
P30 power	
Phoenix 12/800	1200 W
Phoenix 12/1600	2500 W
Phoenix 24/1800	3000 W
Peak power	
Phoenix 12/800	2300 W
Phoenix 12/1600	4500 W
Phoenix 24/1800	6000 W



Switch-on behaviour	The inverter can be switched on at any load.	
Efficiency	Pnom	½Pnom
Phoenix 12/800	84 %	86 %
Phoenix 12/1600	85 %	89 %
Phoenix 24/1800	87 %	89 %
Dynamic stability	maximum 10 % short-term deviations when switching on and off at 50 % of the nominal load	
Restore time	3 periods	
Overload protection	The Phoenix Inverter is protected against overload.	
Short-circuit protection	The output is short-circuit protected. The short-circuit current is approx.:	
Phoenix 12/800	10 Arms	
Phoenix 12/1600	20 Arms	
Phoenix 24/1800	27 Arms	
Protection against mains on inverter output	The output is protected against connecting a not- synchronized main voltage.	

6.3 General

Ventilation	Forced convection (internal)
Protection against too high ambient temperatures, overload and shorting	The temperature of critical components is measured with sensors (PTC 's). The inverter switches off as soon as the maximum temperature of a component is exceeded. When the temperature has fallen, the inverter automatically switches on again.
Relative humidity	0-95%
EMC:	Electromagnetic compatibility in accordance with EMC directive 89/336
Emission	EEC: EN 55014 (1993) EN61000-3-2 EN61000-3-3
Immunity	EN 55104 (1995)
Safety	EN 60950-4 (1991) EN60335-2-29

6.4 Mechanical

Housing	Aluminium, protection class IP21
Colour	Blue (RAL 5012)
Dimensions (h x b x d)	348 x 250 x 205
Weight	
Phoenix 12/800	8,5 kg
Phoenix 12/1600	15 kg
Phoenix 24/1800	15 kg
Connection 230 V AC	Connections to printed circuit board (1 x connector suitable for 4 mm ² wires).
Connection 12 and 24 V DC	Connections to printed circuit board (M8 bolts).
External connections:	
Sensing	Connections to printed circuit board (connector suitable for 1.5 mm ² wires).
Serial interface	8-pole data connector



7. DRAWINGS

Phoenix dimensions	29
Phoenix connection diagram	30

7.1 Dimensions

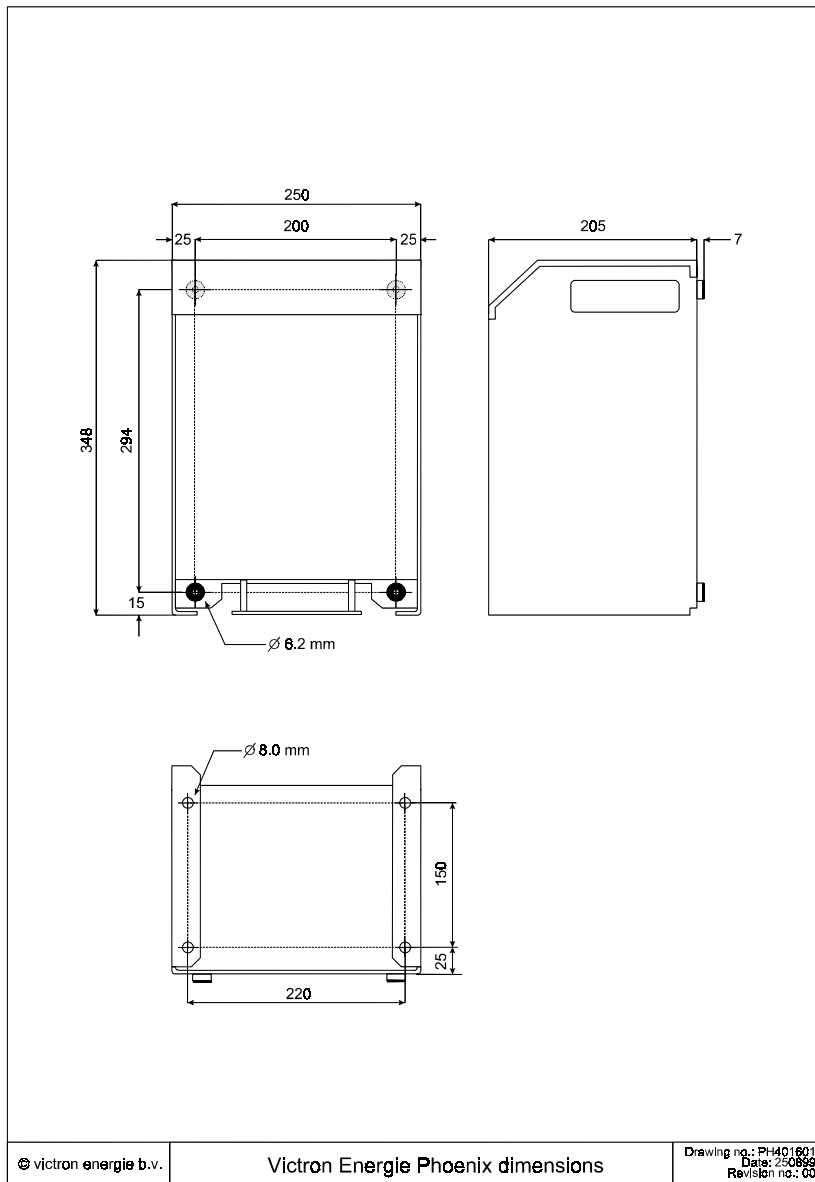

7.2 Connection diagram

